

1.4 MONTAJ ve KULLANIM KILAVUZU

MOUNTING and USER GUIDE

LEDLINE 2XT5

LEDLINE 2XT5 - LINEER LED AYDINLATMA ARMATÜRÜ
LEDLINE 2XT5 - LINEAR LED LIGHTING FIXTURE

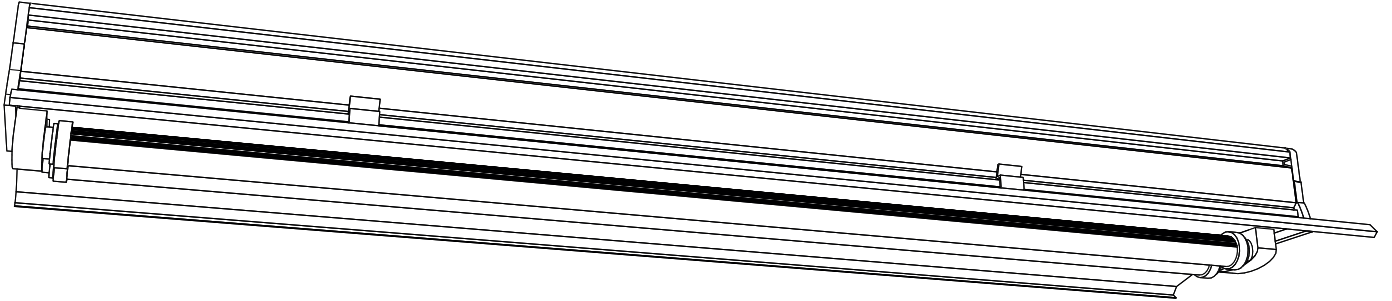

SIVA ÜSTÜ MONTAJ TİPİ - TEKLİ KLİPS / SURFACE MOUNTING TYPE - SINGLE CLIP

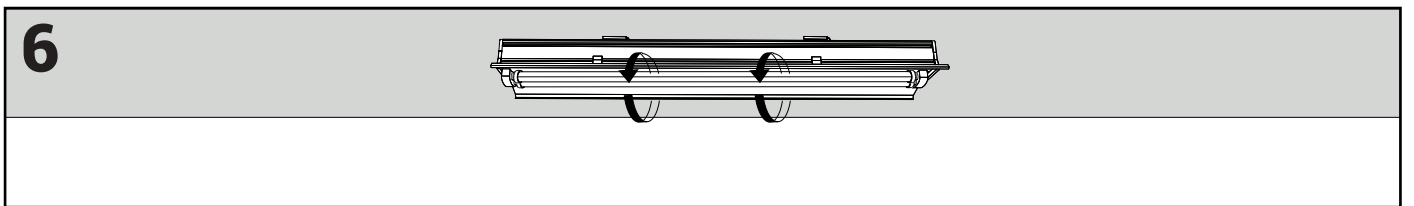
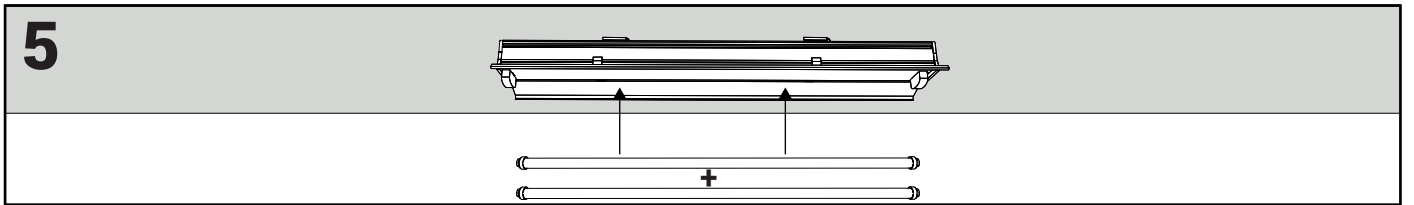
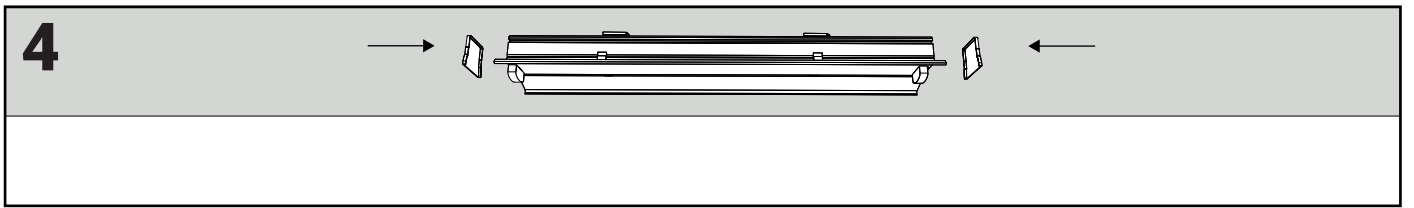
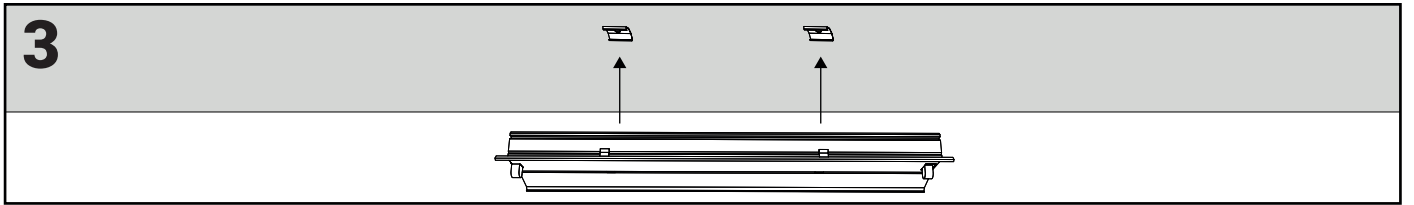
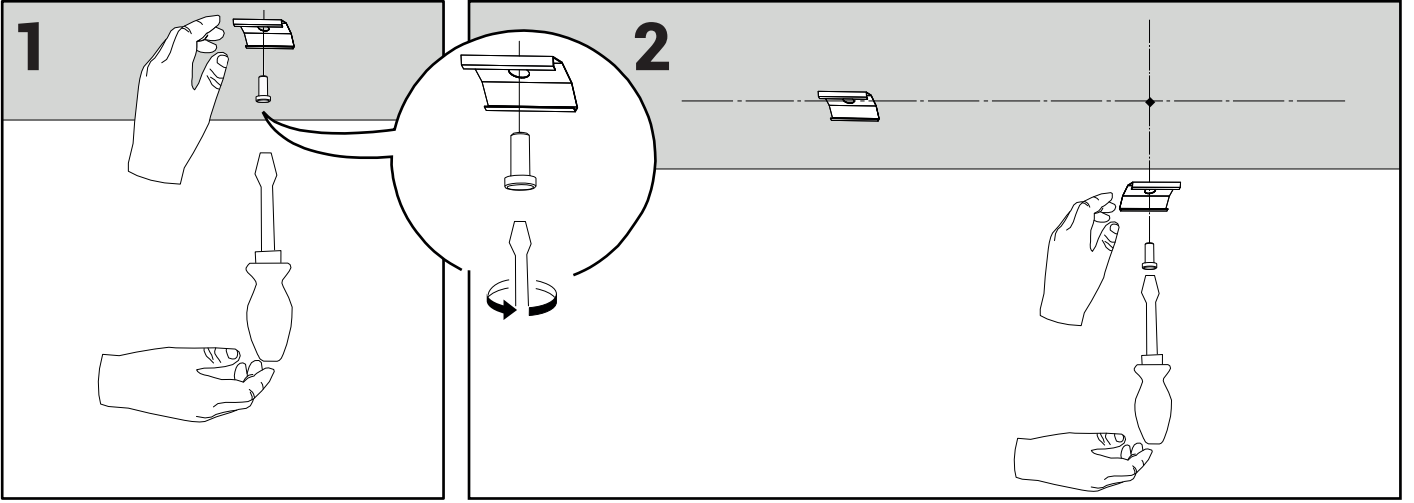
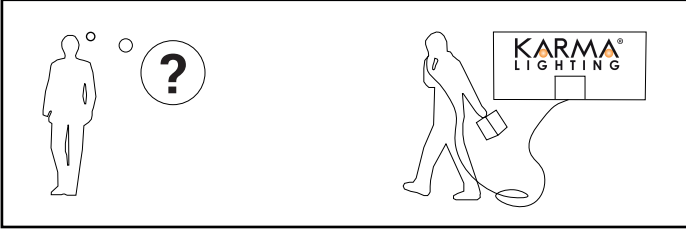

SIVA ÜSTÜ MONTAJ TİPİ - ASKI TELLİ / SURFACE MOUNTING TYPE - SUSPENDED WIRE

